



RAFFINATO

DESCRIPTION: Fire pit **TEXTURE:** Smooth



NOTES

Sold as a kit not pre-assembled.
12"×24" caps included.

Techo-Bloc is not responsible for any damages to the firepit if it is not installed with a sleeve or accessory kit.

See 280 for more technical information.

Specifications per pallet	Imperial	Metric
Approx. Weight	2 700 lbs	1 224 kg
Height	21 ¼ in	540 mm
Depth	41 ½ in	1 054 mm
Length	55 ⅞ in	1 419 mm
12"×24" caps	8	
Raffinato 90 mm corner block	10	
Raffinato 180 mm corner block	20	

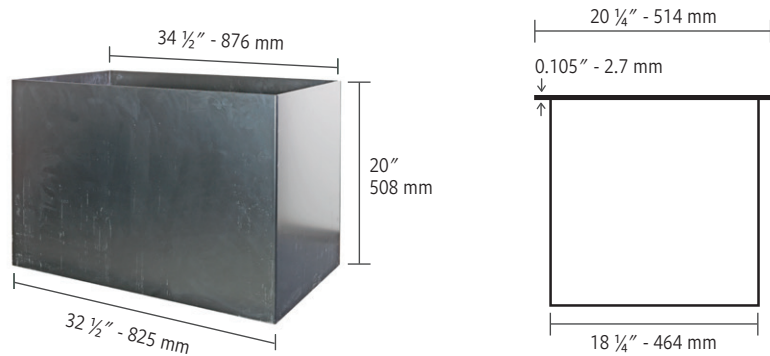

FIRE PIT

Beige Cream /
Greyed Nickel



CAP

Greyed Nickel



FIRE PIT

Greyed Nickel /
Onyx Black



CAP

Onyx Black

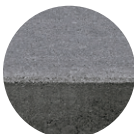

INSTALLATION GUIDE

RAFFINATO FIRE PIT

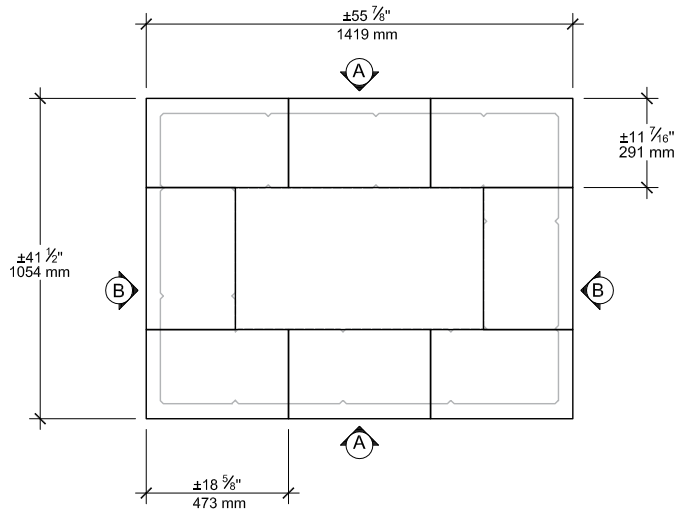

TOP

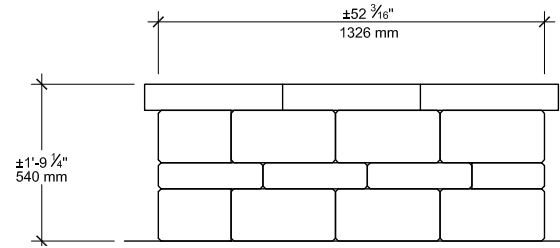

ELEVATION A

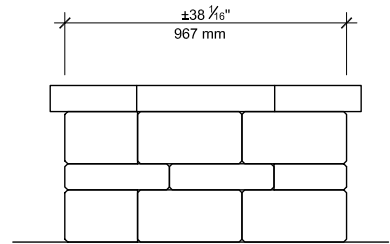

ELEVATION B

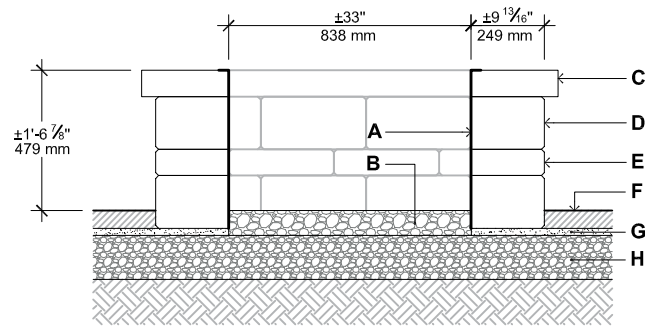

SECTION 1-1

- A. STEEL BOX INSERT
- B. CLEAN STONE 3/4" (20 mm), 4" (100 mm) THICK
- C. 12" x 24" CAP (CUT)
- D. RAFFINATO 180 mm CORNER BLOCK
- E. RAFFINATO 90 mm CORNER BLOCK
- F. TECO-BLOC PAVERS OR SLABS
- G. SETTING BED 1" (25 mm)
- H. COMPACTED GRANULAR BASE 0-3/4" (0-20 mm)

QUANTITY OF MATERIALS REQUIRED

- 12" x 24" cap: **8**
- Raffinato 90 mm corner block: **10**
- Raffinato 180 mm corner block: **20**

NOTE: Secure the blocks using a heat resistant concrete adhesive. The installer must ensure that the installation and use of the firepit comply with local regulations and code requirements.

Consult our Installation Guide in our website for a detail step by step installation.

PLEASE REFER TO P.4 FOR THE CORRECT USE AND LIMITATIONS OF PROVIDED TECHNICAL INFORMATION.